

LOUDSPEAKERS FOR LIFE

GAUDER
AKUSTIK

Formerly
known as
isophon



ARCONA-SERIES
CATALOGUE

ARCONA-SERIES
40 | 60 | 80 | 100





The ARCONA-Series – Latest Technologie by GAUDER AKUSTIK

Our new ARCONA-series inheriting all the state-of-the-art-technologies of all our award-winning loudspeakers (formerly known as Isophon) is offering now perfect sound in the affordable High-End segment. You will be amazed by the clear, transparent sound and the high resolution. And for a wonderful spaciousness our loudspeakers are already legendary. How we do it? Please take your time and follow the notes and explanations for all GAUDER AKUSTIK specific technologies which are unique in the world.

**“There has never been so
much substantial sound in
this price-range before”**
stereoplay 01 / 2013

THE SOFT-LINE CABINET

Left side:
optional spike-extendors made
of sandblasted stainless steel

Right side:
down-firing aerodynamically
optimized bassreflex vent



Sophisticated cabinet shape, acoustically optimized and free of resonances

The slim, drop-shaped cabinet of the ARCONA loudspeakers are built up of 22-mm-strong MDF-board. The soft-line cabinet narrowing backwards avoids all effects of diffraction or reflection thus eliminating bothersome sound colorations. The shape and the inlying stiffening boards are responsible for the high stiffness and provide high dynamics and high resolution. The down-firing bassreflex vent is aerodynamically optimized and excites your listening room evenly so that you can also "feel" the bass.

All loudspeakers of our ARCONA-series are delivered with a black cloth-coated front-grille which is optimized for high acoustical transparency.

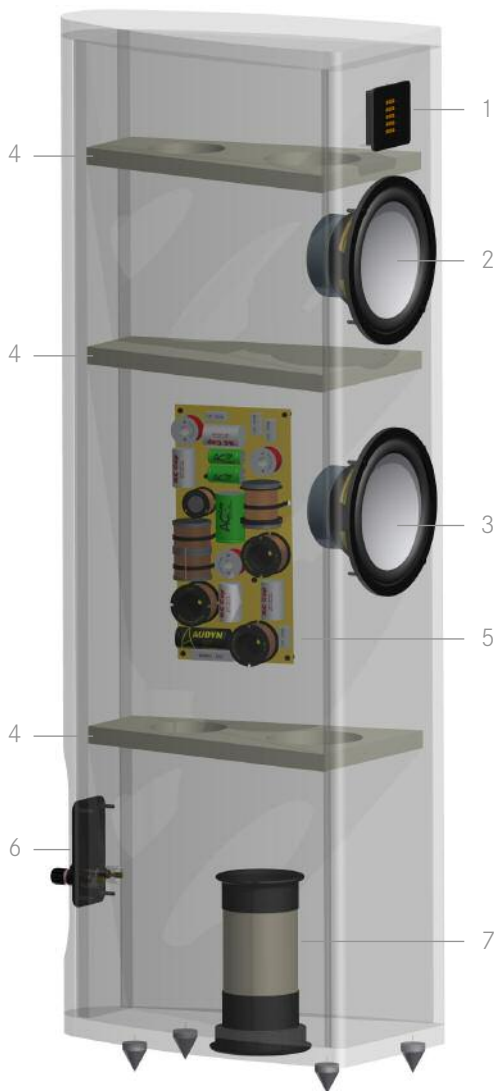

- 1 Air-Motion-Transformer
- 2 Voice-coil with short-circuit ring
- 3 Woofer
- 4 Stiffening and chamber separation
- 5 Frequency crossover
- 6 Connection Terminal
- 7 Bassreflex vent



AIR-MOTION-TRANSFORMER TWEETER

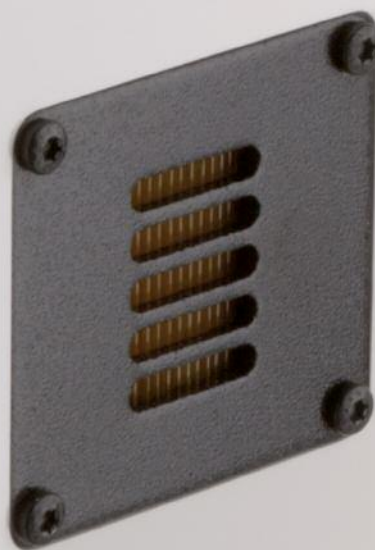

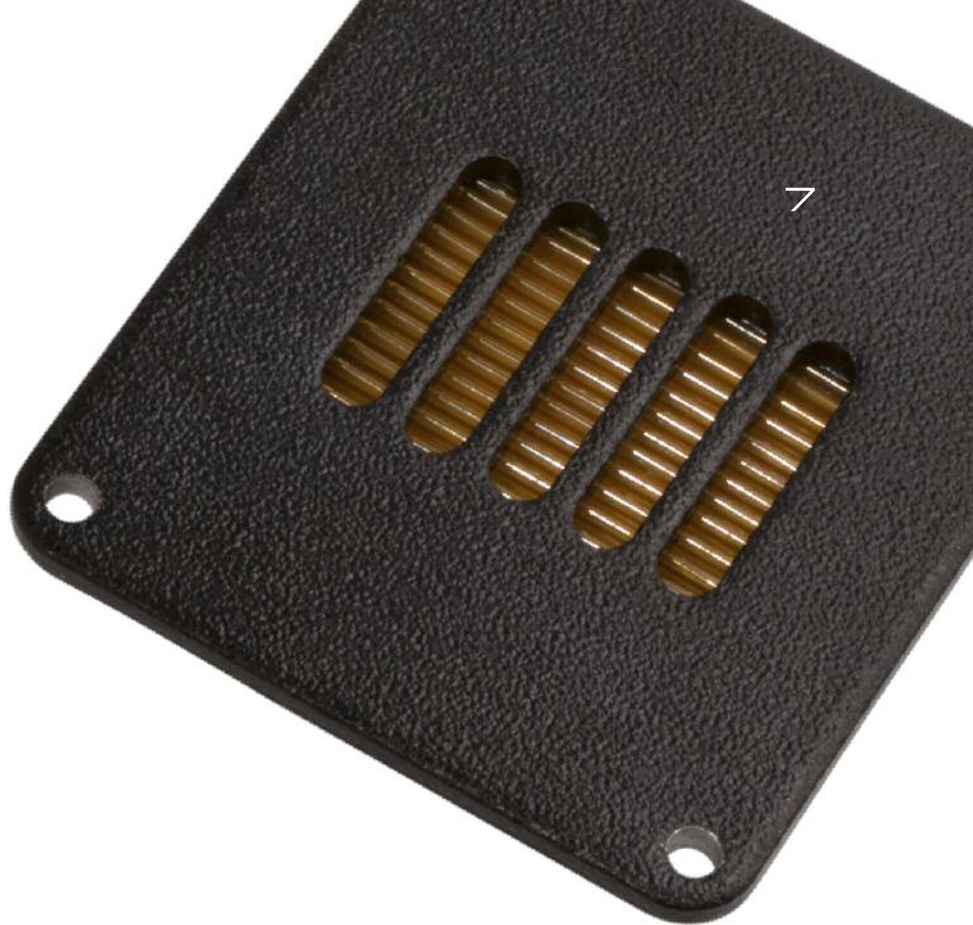

The top-class of tweeters – our new GAUDER AKUSTIK air-motion-transformer

All loudspeakers of our ARCONA-series work with an incredibly fast AMT-tweeter. Its super-strong FeNdB (Iron-Neodymium-Bor)-Magnet accelerates the diaphragm so fast that it reaches a resolution which was not believed to be possible – and this in combination with a very high efficiency.

This tweeter which was invented and developed by Oscar Heil consists of a harmonica-like diaphragm which carries electrically conducting circuit paths. As this diaphragm is placed in a strong magnetic field the single harmonica pockets are contracted and extracted in the rhythm of the applied current. Thus sound is irradiated. Through the harmonica principle the air molecules are accelerated five times higher than by normal dome tweeters.

It doesn't matter if you listen to pop, jazz or classical music – we can promise you this experience of pure fascination by the dynamical, transparent and natural sound of all our ARCONA loudspeakers.



ARCONA X-PULSE DIAPHRAGM

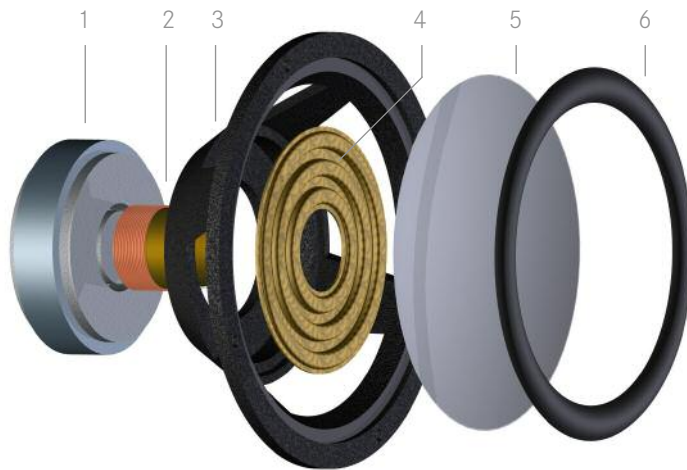

- 1 Magnet with air-gap
- 2 Voice-coil with short-circuit-ring
- 3 Aluminium die cast basket
- 4 Spider
- 5 X-Pulse diaphragm
- 6 Surround

The new patented X-Pulse diaphragm – stiff, light, hard – perfect for woofers and midrange drivers

The X-Pulse diaphragm which was invented and developed by GAUDER AKUSTIK especially for the ARCONA-series consists of aluminium with a backside polymer coating. By selected fillings the diaphragm gains its strength and hardness uniting the positive properties of either soft as well as hard materials. As a result it produces a linear frequency response combined with a perfect impulse response.

Resonances which occur beyond 6.000 Hz are suppressed by our sophisticated ultra-high-slope filter technology so that you cannot hear or measure them.

All these technical features and properties are only there for a perfect, natural music reproduction in all its facets. While hard and soft materials have their own intrinsic sound our X-Pulse-diaphragms are completely free of such coloring effects. So we can only recommend you to listen to our ARCONA loudspeakers and thus to get on a new level of music reproduction.



CO 30/22
1,00mH: R=0,5%
N: Cu 0,13
190 0103

AUDYN-CAP
ELKO glatt
bipolar
82 μ F 35 VAC

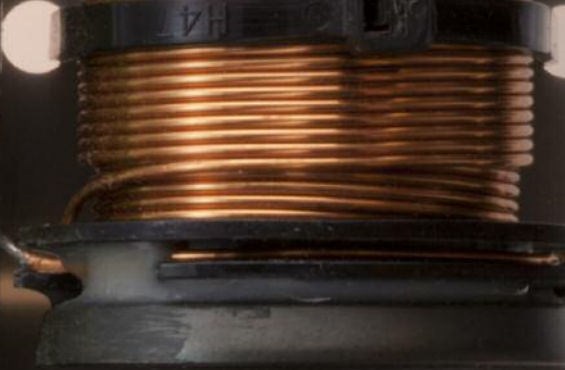

mundorf.com
made in germany
0,1 mH
0,14 Ohm
L100H

Intertechnik
5014 Kerpen
0018 L=0,47 mH R=0,35 Ω ϕ =1,0

Intertechnik
50170 Kerpen
0020 L=0,56 mH ϕ =1,0

M-Cap
Audiophiler
MKP-Kondensator

M-Cap
Audiophiler
MKP-Kondensator
400 VDC Δ C \pm 3 %

AUDYN
33,0 μ F 160V=
MKT \pm 5%
www.intertechnik.de

Intertechnik
5014 Kerpen
0018 L=0,47 mH R=0,35 Ω

Intertechnik
12 Ω \pm 5% 5W

Intertechnik
2,7 Ω \pm 5% 10W

The top-discipline of loudspeaker building – the frequency crossover

Besides the single drive-units and the cabinet the frequency crossover has the biggest effect on the sound of a loudspeaker. The frequency crossover controls and adjusts the interaction and harmony of the single ways within a loudspeaker. It tells the drivers which frequencies to play and at which to go out or in. Thus a more or less wide range of common operation evolves where two or more drivers irradiate the same frequencies. This leads to low resolution, bad impulse response and poor localization.

Already many years ago we started to invent and develop new ways for crossover design which resulted in our unique ultra-high-slope filter technology. All the high- and low-passes in our ARCONA loudspeakers have a slope of more than 50 dB/octave (normal loudspeaker use 6 dB or 12 dB/octave). So the overlap is extremely small which was shown to be beneficial by our big reference loudspeakers.

Uniqely world-wide: the symmetrical design

While normal crossovers only use components in the positive lead our symmetrical crossovers use two components each with the half value in the positive lead as well as in the negative lead of the loudspeaker connection. This symmetry leads to a balanced load of the amplifier thus enabling it to drive the loudspeaker much easier. So all ARCONAS also work with “smaller” amplifiers in a very satisfying way and bring out the sound characteristics of each amp regardless of his output power.

Schematic drawing:
principle of a symmetrical
crossover

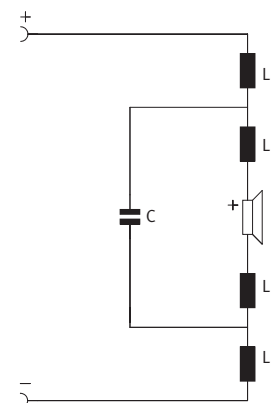

THE BINDING-POSTS



WBT Binding-posts – all the best from the global market leader

Even the best loudspeaker and amplifier cannot provide good sound if there is a bad connection in between them. To avoid all distortions and losses we have equipped the loudspeakers of the ARCONA series with the best available on the world market – the new WBT Nextgen binding-posts. Famous for their know-how and innovations WBT has always made research for best-sounding connectors, binding-posts or RCA plugs taking over the global leadership. So as an ARCONA-owner you will profit from this ultimate knowledge.

The WBT binding posts and the connector plates are delivered in white for ARCONA speakers in white piano high-gloss and in black for blackhigh-gloss and cherry.

Arcona 80

Serial No.:

Impedance 4 Ohms
Sine Power Handling 170 Watt
Impulse Power Handling 310 Watt

Carefully handcrafted in Germany by:
Acoustic Consulting Gauder & Knapp GbR
Merklinger Straße 67 71272 Renningen



ARCONA 80



Available
from now on

The ARCONA 80's working principle is based upon a 2 ½-way-concept whose high power effectiveness and sound performance has already been demonstrated by our award-winning GAUDER AKUSTIK Vescova. The ARCONA 80 possesses two 7"-woofer/midrange drivers with our patented X-Pulse diaphragm and our AMT-tweeter (see page 6 + 7). The lower woofer only reproduces low frequencies up to 120 Hz while the upper one is responsible for both bass and midrange. To optimize this function principle the lower woofer works into a bassreflex cabinet while the upper one due to its midrange response works into a closed-box enclosure which is stuffed with sheep wool. In combination with the frequency crossover a perfect harmony of these different driving modes is guaranteed leading to a fantastic performance. Close your eyes and listen to the virtual image of the orchestra and instruments. That's live!

The German HiFi-magazine stereoplay rated the performance of the ARCONA 80 in its highest ranking category: "Absolute top-class"!



TECHNICAL DATA



ARCONA 40

ARCONA 60

ARCONA 80

Operational principle	2 ways, closed-box	2 ½ ways, combined	2 ½ ways, combined
Bassreflex	closed-box	down-firing vent	down-firing vent
Highpass filter	yes	direct	direct
Woofer	1 x 7"	2 x 5"	2 x 7"
Midrange	-	-	-
Tweeter	AMT	AMT	AMT
Impedance [Ohm]	4	4	4
Sine power handling [W]	100	130	170
Height (cm) [inch]	36 [14.2"]	99 [39"]	105 [41.5"]
Width (cm) [inch]	21 [8.3"]	18 [7"]	21 [8.3"]
Depth (cm) [inch]	33 [13"]	28 [11"]	39 [15.4"]
Efficiency	normal	normal	normal
Frequency range	wide	wide	wide
Weight (kg) [lbs]	12 [26.5]	18 [40]	24 [53]
Warranty	10 years	10 years	10 years



The most important quality of a loudspeaker is its sound and naturality. These facts cannot be described in numbers. Please do not buy loudspeakers based on such criteria like “efficiency” or “frequency range” as these numbers have nothing to do with sound quality. In reverse, a high efficiency is most often combined with bad sound. Frequency range is not a protected definition but used different in every country. We therefore do not publish any of these fooling data.



ARCONA 100

FRC

Operational principle	3 ways	2 ½ ways, closed-box
Bassreflex	double bass, vent downfiring	closed-box
Highpass filter	yes	yes
Woofer	2 x 7"	2 x 5"
Midrange	1 x 7"	-
Tweeter	AMT	AMT
Impedance [Ohm]	4	4
Sine power handling [W]	270	160
Height (cm) [inch]	114 [45"]	21 [8.3"]
Width (cm) [inch]	21 [8.3"]	48 [19"]
Depth (cm) [inch]	39 [15.4"]	35 [13.8"]
Efficiency	normal	normal
Frequency range	wide	wide
Weight (kg) [lbs]	29 [64]	17 [38]
Warranty	10 years	10 years



GAUDER AKUSTIK
LOUDSPEAKERS FOR LIFE

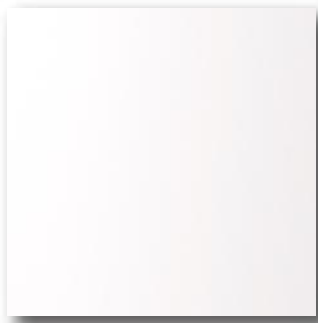

All ARCONA models are available in cherry, piano high-gloss black and piano high-gloss white. Deviations to the pictures shown are due to printing.

The accessories kit consists of: adjustable spike tops, spike platters, a bubble level for correct adjusting, a black cloth-coated front-grille velcro tape fixed, a pair of gloves, a polish cloth, polish paste (only piano high-gloss).

Optionally available are individually adjustable spike extenders which ensure the stand of all ARCONA loudspeakers (see page 4).



**GAUDER AKUSTIK Loudspeakers
and Clearwater cable by:**

Acoustic Consulting
Gauder & Knapp GbR
Merklingerstr. 67
DE - 71272 Renningen
Germany

Tel: +49-71 59-92 01 61
Fax: +49-71 59-92 01 62

e-mail: info@acga.de
www.gauderakustik.com



GAUDER AKUSTIK on Facebook.com



GAUDERAKUSTIK.COM

